

Data Sheet



Article number: 021400700031

Description: Sealing Clamp S 31 W5

Measures

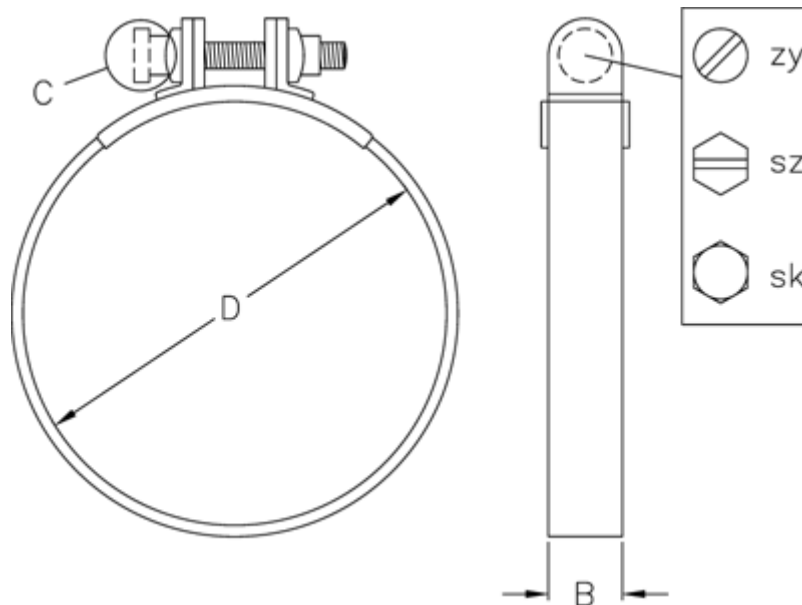

C (screw type) = SZ

Diameter D = 31

Width B = 15